

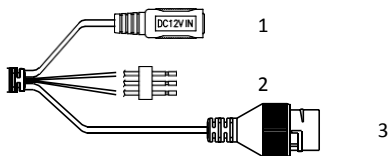

How to install this PTZ Dome Camera

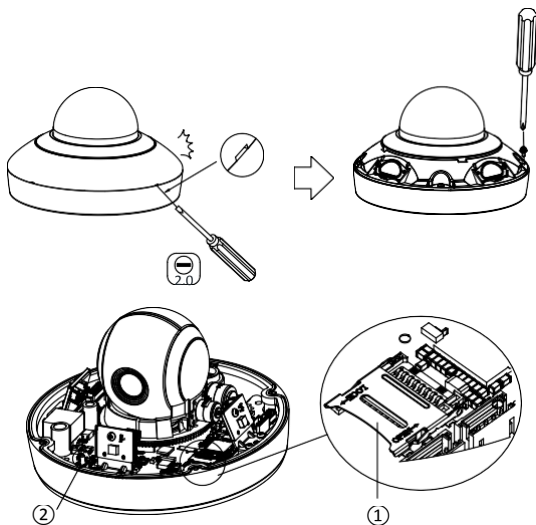

A**B**

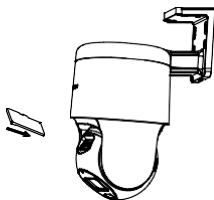
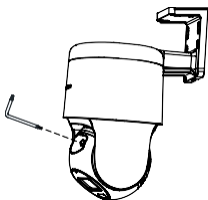
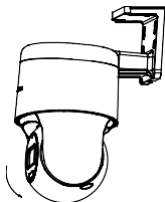

C

C1

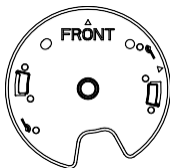
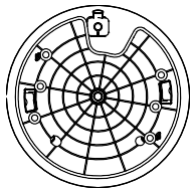

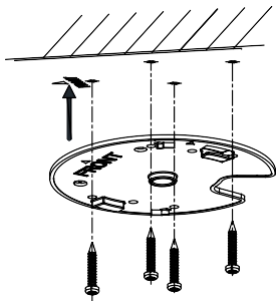

C2.2

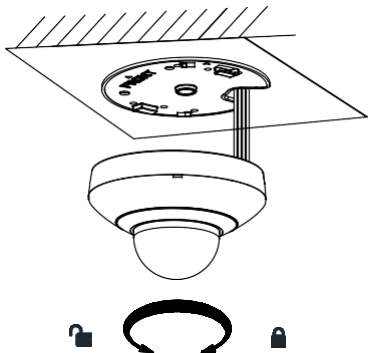

C3.1

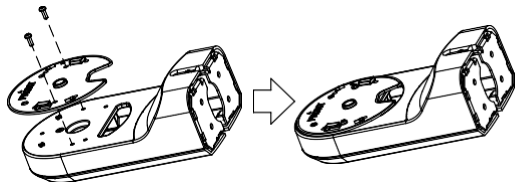

C3.2

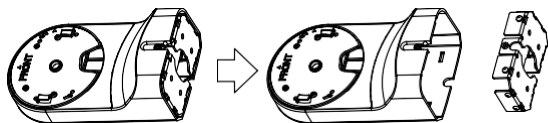

C3.3

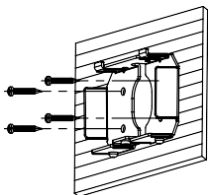

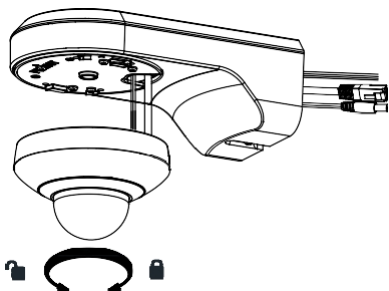

C3.5

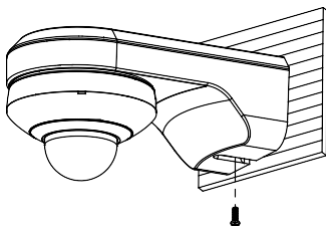

C4

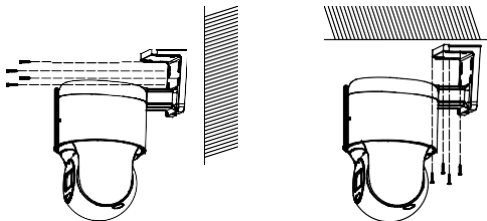

C3.4

D

1

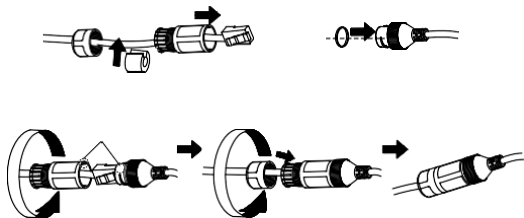

2

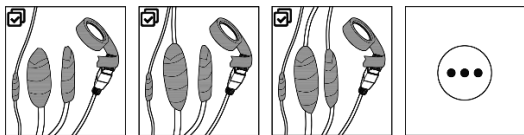
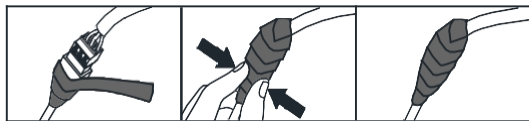
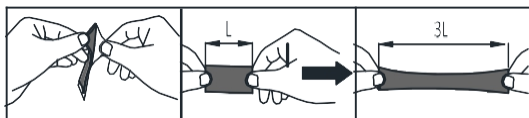

E

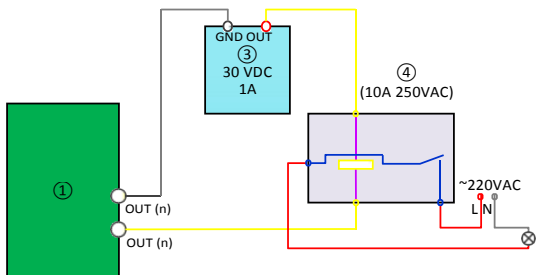
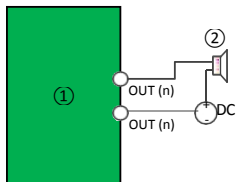

F



F1

F2